



Now Powered by LightField™

PIXIS: 512

The PIXIS: 512 series of cameras from Princeton Instruments (PI) are fully integrated, low noise cameras designed expressly for quantitative scientific imaging applications. Choose back-illuminated (B) or eXcelon™ versions of the 512 x 512 CCD for optimized performance from UV to NIR. Designed utilizing PI's exclusive XP cooling technology, PIXIS are the only cameras that offer cooling up to -90°C, while the all-metal, hermetically sealed design, with the industry's only lifetime vacuum guarantee, ensures maintenance free operation. High QE and ultra low-noise electronics make the PIXIS: 512 series of cameras ideal for demanding, low light applications such as astronomy, Bose-Einstein Condensate (BEC), chemiluminescence and fluorescence imaging. The eXcelon technology of the PIXIS:512B delivers higher sensitivity in the NIR while suppressing the etaloning that occurs in standard back illuminated CCDs. Dual speed operation at 100kHz or 2MHz allow these cameras to be used for steady state as well as fast kinetics studies.

FEATURE	BENEFITS
eXcelon™ technology	Higher QE in the UV and near IR regions; Extremely low etaloning; 100x lower dark charge than conventional back-illuminated deep depletion devices
512 x 512 imaging array; 24 μm x 24 μm pixels Scientific grade CCD	High spatial resolution; Low noise, few defects, linear response
All-metal, hermetic vacuum seals; Lifetime vacuum guarantee	No out-gassing (as in epoxy seals) which can compromise vacuum performance; Worry-free operation
Deep cooling	Low dark noise allows detection of faint signals; CoolCUBE II, a compact room temperature coolant circulator, is available for vibration sensitive environments
Single fused silica vacuum window	Minimizes reflection losses from UV to IR; No optical losses due to multiple optical surfaces; Optional AR coating and wedge windows available
Optional UV phosphor coatings	Enhances sensitivity throughout the UV to below 200 nm (not available for eXcelon cameras)
TTL input and output, and shutter control	External control and triggering
Low noise electronics	Best performance for low light level applications
Dual amplifiers with software-selectable system gains	High sensitivity amplifier reduces the read noise floor for weak signals while the high capacity amplifier increases dynamic range
Kinetics	Custom readout mode offers microsecond resolution
USB2.0 data interface	Plug-and-play operation with desktops or laptops; Optional fiber optic interface for remote operation
LightField™ for 64-bit Windows 7 or WinSpec for 32-bit Windows	Flexible software packages for data acquisition, display and analysis; LightField offers intuitive, cutting edge user interface, IntelliCal™ and more
PICAM/PVCAM software development kits (SDKs)	Universal programming interfaces for easy custom programming; Compatible with Windows XP/Vista/7 and Linux

Applications:

semiconductor failure analysis, astronomy, photometry, laser beam profiling, luminescence and fluorescence imaging, and Bose-Einstein Condensate (BEC)

SPECIFICATIONS

	PIXIS: 512B_eXcelon 	PIXIS: 512B
Features	Back-illuminated CCD. Highest sensitivity in the visible region. High sensitivity in the NIR. Extremely low etaloning. 100x lower dark charge than the BR.	Back-illuminated CCD. Highest sensitivity in the visible region.
CCD Image Sensor	Princeton Instruments' proprietary CCD, back-illuminated, grade 1, AIMO	e2v CCD77-00 back-illuminated, grade 1, AIMO
Dark current @ -70°C	0.001 e-/p/sec (typical) 0.003 e-/p/sec (max)	0.001 e-/p/sec (typical) 0.003 e-/p/sec (max)
CCD UV coating	Optional UV coating (not needed for BUUV version)	
Quantum efficiency	See graph, next page	
CCD format	512 x 512 imaging pixels; 24 x 24 μm pixels; 100% fill factor	
Imaging area	12.3 mm x 12.3 mm (optically centered)	
Lens mount	Adjustable c-mount with integral 25 mm shutter	
Deepest cooling temperature	-90°C typical; -70°C guaranteed, specified at ambient temperature of +20°C	
Thermostating precision	±0.05°C	
Cooling method	Thermoelectric air or liquid cooling (CoolCUBE II required)	
Full well:	Single pixel	300 ke- (typical), 250 ke- (min)
	Output node	700 ke- (typical), 600 ke- (min)
ADC speed/bits	100 kHz/16-bit and 2 MHz/16-bit	
System read noise		
@ 100 kHz	5 e- rms (typical), 9 e- rms (max)	
@ 2 MHz	12 e- rms (typical), 20 e- rms (max)	
Vertical shift speed	18 μsec/row (programmable)	
Non-linearity	<1% @ 100 kHz	
Software selectable gains	2.5, 5, 10 e-/ADU; available at all speeds	
Operating systems supported	Windows XP/Vista/7, and Linux	
Data interface	USB2.0 (5 M interface cable provided); Optional Fiberoptic interface is available for remote operation	
I/O signals	Two MCX connectors for programmable frame readout, shutter, trigger in	
Operating environment	+5 to +30°C non-condensing	
Certification	CE	
Dimensions / Weight	16.59 cm (6.53") x 11.81 cm (4.65") x 11.38 cm (4.48") (L x W x H) / 2.27 kg (5 lbs)	

All specifications are subject to change.

FRAME RATE

	Readout Time		
	@ 2 MHz	@ 100 kHz	
Binning	1 x 1	152.1 msec	2.52 sec
	2 x 2	77.4 msec	0.7 sec
	4 x 4	41.6 msec	219.3 sec

QE DATA

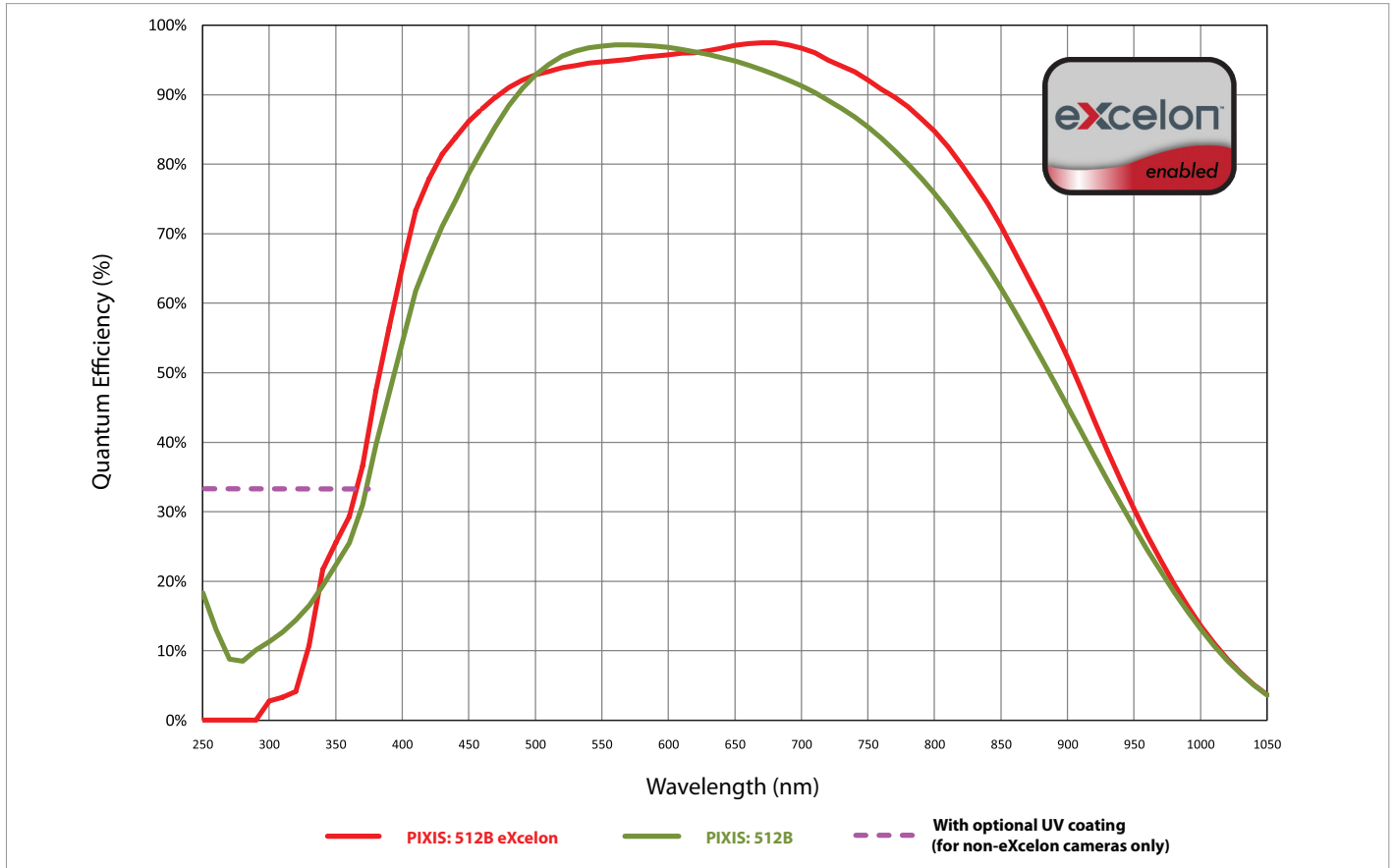

NOTE:

Graph shows typical Quantum Efficiency (QE) data measured at + 25°C. QE decreases at normal operating temperatures. For the best results for your application, please discuss the specific parameters of your experiment with your sales representative.

VACUUM WINDOW AR COATINGS

NOTE:

Standard anti-reflection (AR) coatings shown. Custom AR coatings and wedge window options are also available. Contact your local sales representative for more information.

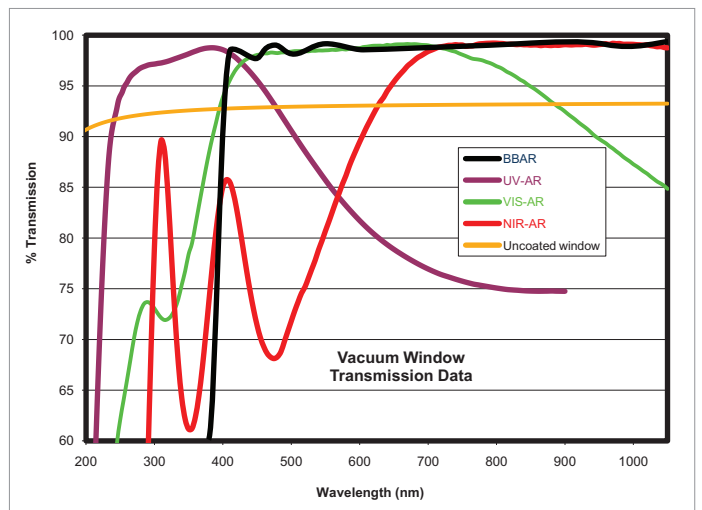

eXcelon Performance

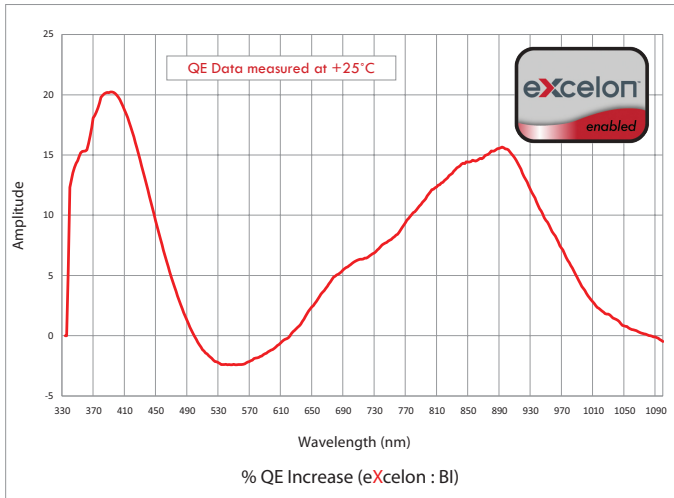

B_eXcelon provides superior QE over the standard back illuminated ("B") version in the UV-NIR range.

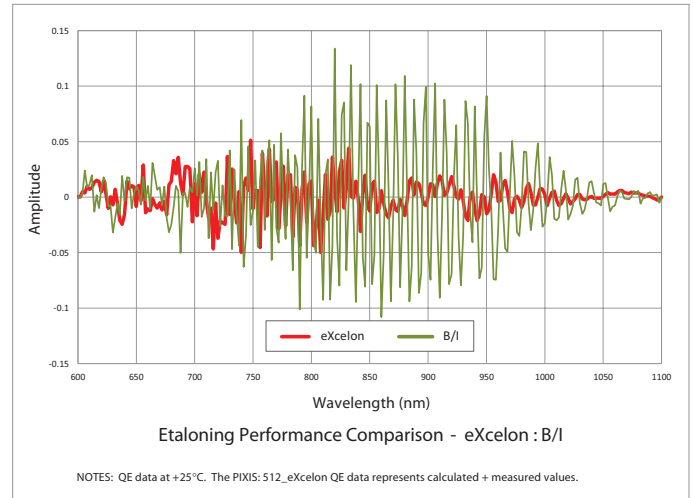

B_eXcelon provides significantly lower etaloning (unwanted fringes) compared to standard back illuminated ("B") version.

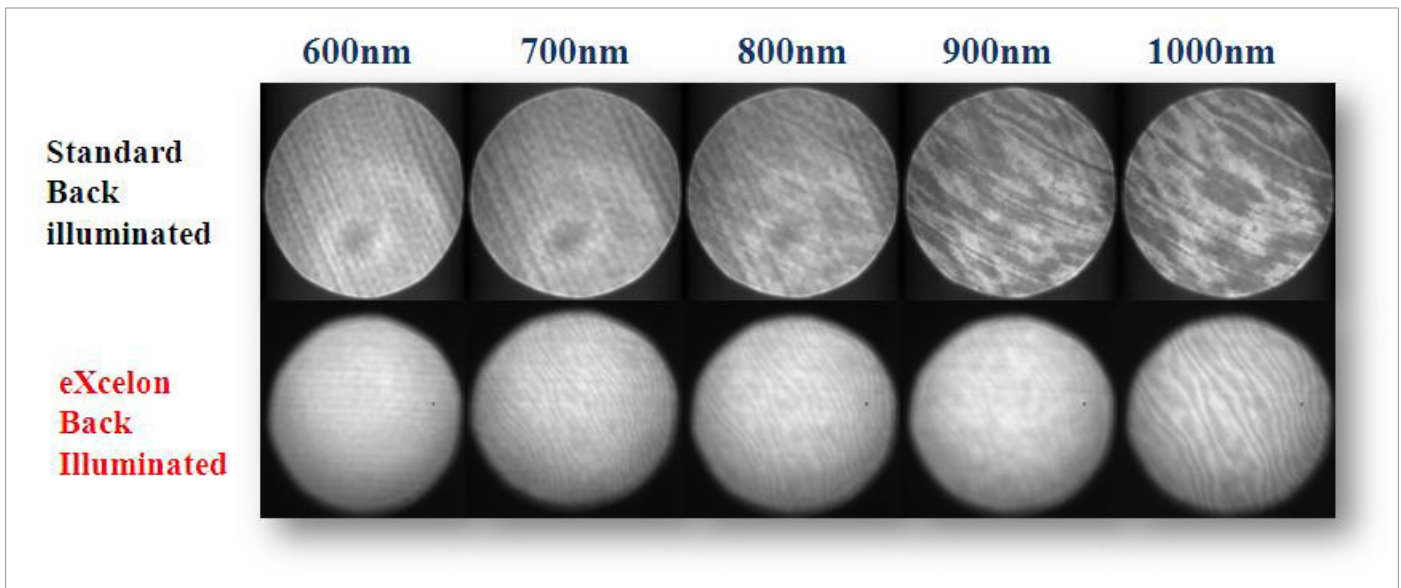

Data taken with white light source through a monochromator comparing etaloning performance of eXcelon vs. back-illuminated CCDs.

PIXIS: 512 (AIR COOLED)

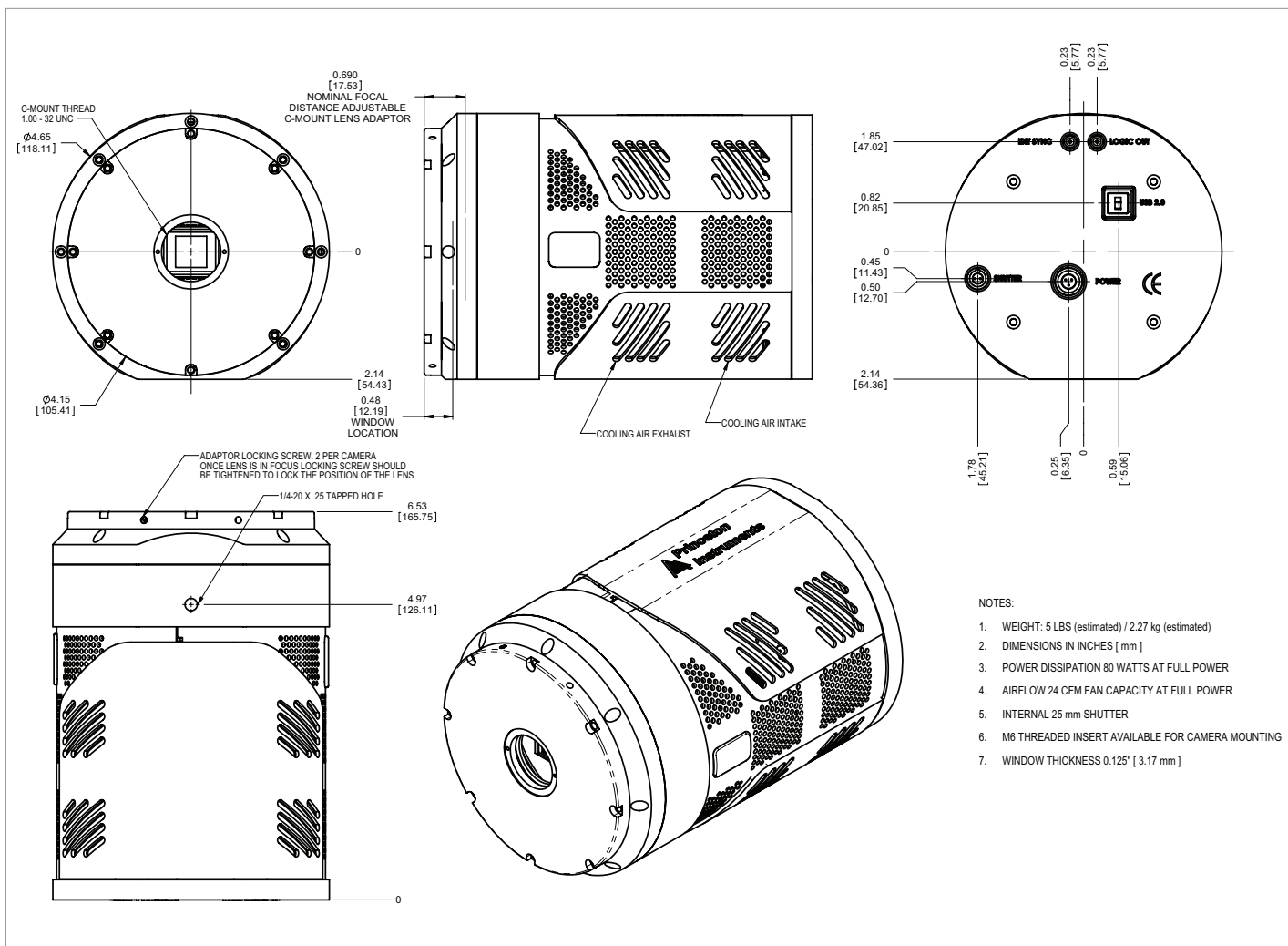

PIXIS: 512 (LIQUID COOLED)

